

The following features are available in this PDF document.



Quick Keyword Search

Enter the keyword in the search box and hit the search button



Quick Jump between Chapters

Click the title of a specific chapter on the Contents to jump to it

*Reading software such as Adobe Reader is needed to support the functions above.



ZHIYUN FIVERAY M20

User Guide

Contents

<input type="checkbox"/> Brief Introduction	
Brief Introduction	1
<input type="checkbox"/> Product List	
Product List	3
<input type="checkbox"/> Get to Know ZHIYUN FIVERAY M20	
Get to Know ZHIYUN FIVERAY M20	5
<input type="checkbox"/> Charging	
Charging	6
<input type="checkbox"/> Installing Modifiers	
Installing/Removing ZHIYUN FIVERAY M20 Extension Bracket (hereinafter referred to as “extension bracket”)	7
Installing/Removing ZHIYUN FIVERAY M20 Diffuser (hereinafter referred to as “diffuser”)	9
Installing/Removing ZHIYUN FIVERAY M20 4-Leaf Barn Doors (hereinafter referred to as “4-leaf barn doors”)	10
Installing/Removing ZHIYUN FIVERAY M20 Honeycomb Grids (hereinafter referred to as “honeycomb grids”)	11
<input type="checkbox"/> Mounting the Tripod	
Mounting the Tripod	12
<input type="checkbox"/> Using with a Camera	
Using with a Camera	13
<input type="checkbox"/> Attaching the Fill Light Magnetically	
Attaching the Fill Light Magnetically	14







<input type="checkbox"/>	How to Use ZHIYUN FIVERAY M20	
	Buttons and Dials	15
	Operation Instruction	16
<input type="checkbox"/>	Firmware Upgrade	
<input type="checkbox"/>	Product Specifications	
<input type="checkbox"/>	Disclaimer and Warnings	
	Reading Tips	21
	Safe Operation Instructions	21
<input type="checkbox"/>	Warranty Card	
	Warranty Period	22
	Warranty Exclusions	22
	Warranty Claim Procedure	22
<input type="checkbox"/>	Contact Card	

Brief Introduction

ZHIYUN FIVERAY M20 is a high-power, portable LED pocket fill light that features a stylish appearance and compact size. It supports color temperature adjustment and offers various creative light effects. The product has the following highlights:

1. Lightweight and portable with simple operation.
2. Allows for adjustable brightness/color temperature, suitable for a wide range of applications.
3. High color rendering performance, accurately reproducing the true colors of objects.
4. Equipped with DynaVort Cooling System™ for excellent heat dissipation.
5. Supports music mode for a great music scene atmosphere.
6. Offers a variety of light effects for creative shooting scenarios.
7. Comes with complete accessories, providing easy and efficient light control.

WARNING

-  This product is not waterproof. Prevent contact with any kind of liquid with the ZHIYUN FIVERAY M20. Never use the product in the rain or a humid environment.
-  If water accidentally enters the device when using, please stop using it immediately and contact the company or authorized maintenance personnel for maintenance, and continue to use it only when the maintenance is finished.
-  Do not expose this product to corrosive chemicals, inflammable and explosive materials.
-  Do not touch the heating part when the product is working to avoid getting burned.
-  Do not wrap or block the fans to avoid cooling effect damage.
-  Do not turn the product directly to the eyes to avoid eyesight damage.
-  Do not expose this product to an environment above 40°C .

⚠ Battery safety precautions:

- ① It is strictly prohibited to use batteries that are not provided by ZHIYUN. If you need to replace the battery, please contact ZHIYUN or designated agents. ZHIYUN will not be responsible for any battery accidents or equipment malfunctions caused by using batteries that are not officially provided by ZHIYUN.
- ② If the battery bulges, leaks, or has other abnormalities, please stop using it immediately and contact ZHIYUN customer service or designated agents for further processing.
- ③ Do not completely discharge the battery and store it for a long time to prevent the battery from entering an over-discharged state and causing damage to the battery cell, which may make it impossible to recover and reuse.

BE CAREFUL

1. This product is a high-precision control device. Damage may be caused to the product if dropped or subject to external force, and this may result in malfunction.
2. When storing or using the product with ZHIYUN FIVERAY M20 Extension Bracket, please keep them away from items that are easily magnetized, such as floppy disks, bank cards, ID cards, access cards, etc.
3. Please keep your hands dry while using the product and use a soft dry cloth for cleaning.
4. Keep this product out of the reach of children.
5. When not using this product, please disconnect the external power supply.
6. Do not place any other items on top of this product to avoid damage to this product.
7. Protect the product from dust and sand during use.
8. Before storing this product, please make sure it is completely cooled and store it in a dry and ventilated place.
9. Do not disassemble this product on your own. In the event of malfunctions, it should be repaired by ZHIYUN or authorized maintenance personnel.

Product List

Before using this product, please check carefully that all the following items are included in the product package. In case that any item is found missing, please contact ZHIYUN or your local selling agent.

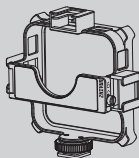
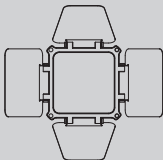
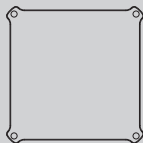

Main Device x1

ZHIYUN FIVERAY M20 Extension
Bracket x1ZHIYUN FIVERAY M20 4-Leaf Barn
Doors x1*

ZHIYUN FIVERAY M20 Diffuser x1*

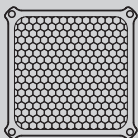
ZHIYUN FIVERAY M20 Honeycomb
Grids x1*

ZHIYUN FIVERAY M20 Storage Bag x1*

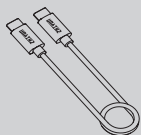

USB Type C Cable x1



Quick Start Guide x1

Items marked “**” are only included in ZHIYUN FIVERAY M20 COMBO package.

Get to Know ZHIYUN FIVERAY M20

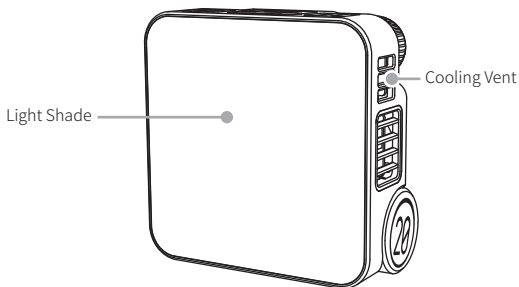
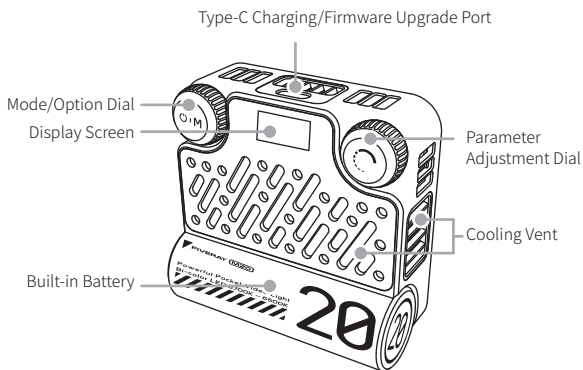

Charging

This product uses a built-in battery to ensure sufficient battery life. You can view the remaining battery level on the display screen. When the battery is low, you can charge it while still using the light using the following method:

Charging Method: Use the provided USB Type-C cable to connect the fill light to a USB charger. It is recommended to use a USB charger that supports the PD (Power Delivery) fast charging protocol. When charging while using the fill light, the USB charger will prioritize powering the fill light, and the remaining power will be used to charge the battery. The maximum PD charging power supported by the battery is 12W.

AC Power
(100-240V)



USB Charger



USB Type-C Cable



- ① It is recommended to fully charge M20 before using it. Low battery might impair the product performance.
- ② USB chargers are not included in the package.

Installing/Removing ZHIYUN FIVERAY M20 Extension Bracket (hereinafter referred to as “extension bracket”)

Installing:

Push the lock switch of the lateral baffle upward ① and turn the lateral baffle outward ② . Place ZHIYUN FIVERAY M20 into the extension bracket ③ . Finally, Turn the lateral baffle inward and apply slight pressure until the lock switch automatically locks ④ .

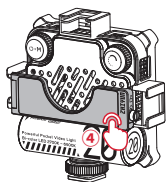
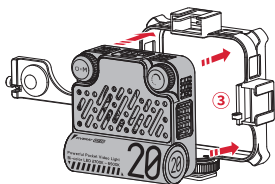
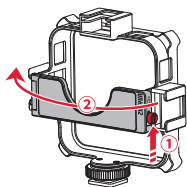

Removing:

Push the lock switch of the lateral baffle upward ① and turn the lateral baffle outward ② . Remove the ZHIYUN FIVERAY M20 from the extension bracket ③ . Finally, Turn the lateral baffle inward and apply slight pressure until the lock switch automatically locks ④ .

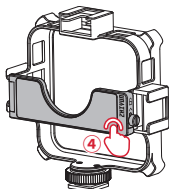
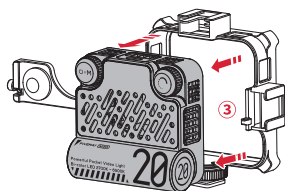
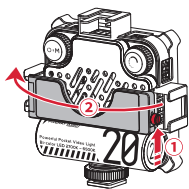

Installing/Removing ZHIYUN FIVERAY M20 Diffuser (hereinafter referred to as “diffuser”)

Install the extension bracket onto the ZHIYUN FIVERAY M20, then align the four corners of the diffuser with the four corners of the extension bracket and attach them. When disassembling, simply remove the diffuser from the extension bracket.

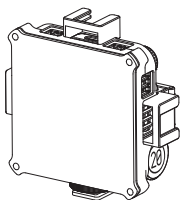
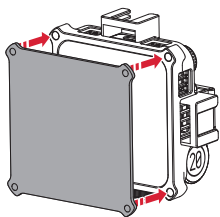

Installing/Removing ZHIYUN FIVERAY M20 4-Leaf Barn Doors (hereinafter referred to as “4-leaf barn doors”)

Installing:

Install the extension bracket onto the ZHIYUN FIVERAY M20, then align the four corners of the four-leaf barn doors with the four corners of the extension bracket and attach them ①. You can unfold the four panels of the four-leaf barn doors to the appropriate angle ②. Mount the diffuser onto the four-leaf barn doors ③. When disassembling, simply remove the diffuser and the four-leaf barn doors from the extension bracket in sequence.

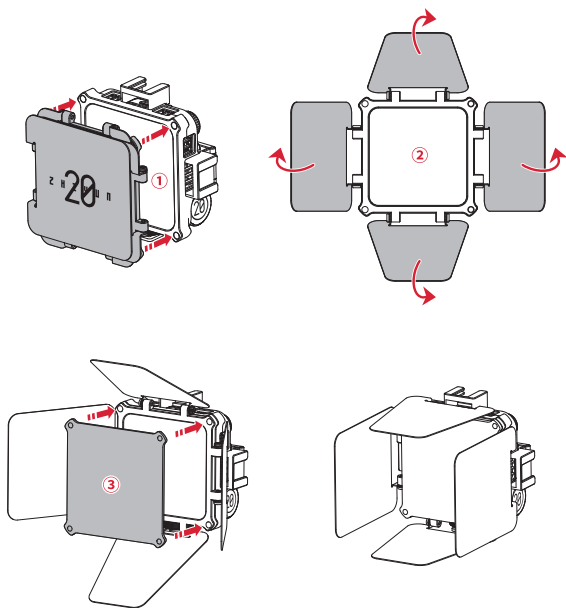

Installing/Removing ZHIYUN FIVERAY M20 Honeycomb Grids (hereinafter referred to as “honeycomb grids”)

Install the extension bracket onto the ZHIYUN FIVERAY M20, then align the four corners of the honeycomb grids with the four corners of the extension bracket and attach them. When disassembling, simply remove the honeycomb grids from the extension bracket.

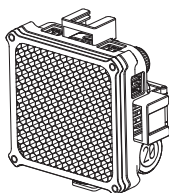
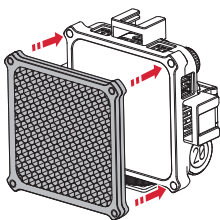

Mounting the Tripod

Install the extension bracket to the ZHIYUN FIVERAY M20, and then mount the extension bracket and fill light as a whole on the tripod.

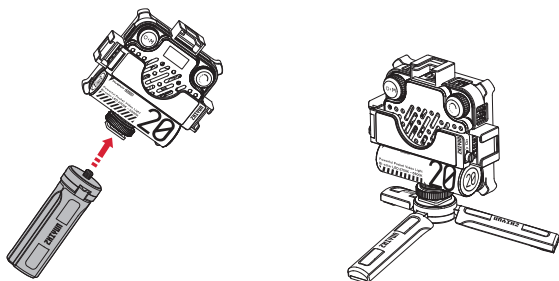

Using with a Camera

Install the extension bracket onto the ZHIYUN FIVERAY M20, align the cold shoe at the bottom of the extension bracket with the cold shoe mount on top of the camera, and then attach the extension bracket and the fill light as a whole to the camera's cold shoe.

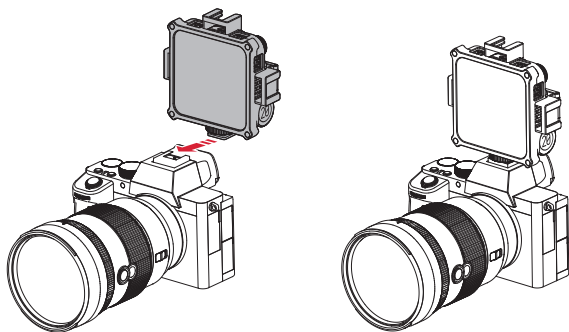

Attaching the Fill Light Magnetically

Install the extension bracket to the ZHIYUN FIVERAY M20, and then you can magnetically attach the entire assembly to the surface of a metal object.

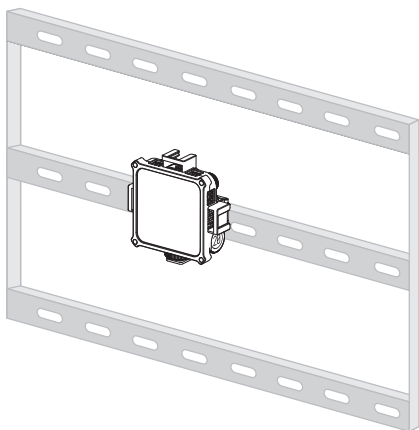

⚠ DO NOT stare at the LED chips when the device is operating.

⚠ The IP rating of the outer case is IP20.

Buttons and Dials



Mode/Option Dial:

Single press+long press: Power on

Long press: Power off

Single press: Switch modes

Double press: Switch to the previous mode

Turn: Switch options (in submenu)

Adjust the parameter (in CCT/Music interface)

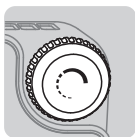

Parameter Adjustment Dial:

Single press: Quickly adjust the current parameter
Confirm (submenu)

Turn: Adjust the current parameter

Operation Instruction

1. CCT Mode Settings

In the CCT mode, you can freely adjust the brightness and color temperature of ZHIYUN FIVERAY M20. Power on the fill light, and use a single press or double press on the mode/option dial to switch to the CCT mode. Turn the mode/option dial to finely adjust the color temperature value, and use a single press on the parameter adjustment dial to quickly set the brightness value. Turn the parameter adjustment dial to finely adjust the brightness value. Please adjust the brightness and color temperature values properly to suit your actual scenario.

CCT	
BRT:	100%
CCT:	5500k

2. FX Mode Settings

The FX mode offers ten different light effects, including SOS, Paparazzi, Candlelight, Faulty Bulb, TV, Lightning, Strobe, Color Temperature Cycle, Color Temperature Flicker, and Color Temperature Flashing, allowing you to create creative and atmospheric scenes. To activate the FX mode on the ZHIYUN FIVERAY M20 fill light, power on the ZHIYUN FIVERAY M20 fill light, and press or double-press the mode/option dial to switch to the FX mode. Use a single press or turn the parameter adjustment dial to select the desired light effect type. Turn the mode/option dial to switch among brightness/speed/color temperature options. Use a single press on the parameter adjustment dial to quickly set the brightness, speed, or color temperature value. Turn the parameter adjustment dial to finely adjust the brightness, speed, or color temperature value. Please adjust the brightness, speed, and color temperature values as needed to create the appropriate light effect for your specific usage scenario.

FX	
FX:	SOS
DIM:	100%
SPD:	5 ▼

 The parameter values in a single light effect are only effective for that light effect.

3. Music Mode Settings

In the music mode, the lighting of ZHIYUN FIVERAY M20 can dynamically change in sync with the rhythm of the music, creating a more immersive music atmosphere. To activate the music mode on the fill light, turn on the fill light. Press or double-press the mode/option dial to switch to the music mode. Turn the mode/option dial to finely adjust the color temperature value. Use a single press on the parameter adjustment dial to quickly set the brightness value. Turn the parameter adjustment dial to finely adjust the brightness value. Please adjust the brightness and color temperature values as needed to suit your specific usage scenario.

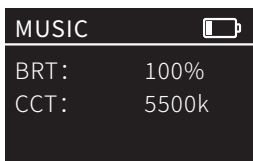

4. Menu Settings

Turn on the ZHIYUN FIVERAY M20, press or double press the mode/option dial to switch to "MENU." Turn the parameter adjustment dial to navigate to the "Language" option. Finally, press the parameter adjustment dial once to confirm your selection.

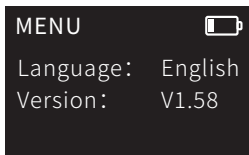

 Under the "MENU" option, you can also check the firmware version information for the ZHIYUN FIVERAY M20.

You can use "Zhiyun Led Tools" to perform the ZHIYUN FIVERAY M20 firmware upgrade. The steps are as follows:

1. Visit the official website of ZHIYUN (www.zhiyun-tech.com), go to the ZHIYUN FIVERAY M20 product page, click "Download", find the Zhiyun Led Tools and the firmware and download.
2. Unzip the firmware for the files with the ".ptz" file extension.
3. Connect the USB-C port of ZHIYUN FIVERAY M20 to the USB port of the computer with the USB Type-C cable.
4. Open "Zhiyun Led Tools", click "Open", and click "Firmware Upgrade". Click "Browse" under "Path" to select the latest firmware downloaded (with the ".ptz" file extension), and click "Upgrade" at the bottom to upgrade firmware. ZHIYUN FIVERAY M20 will automatically turn off when the upgrade is finished.

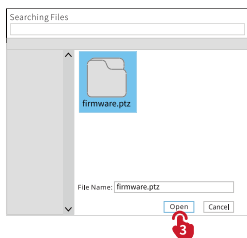
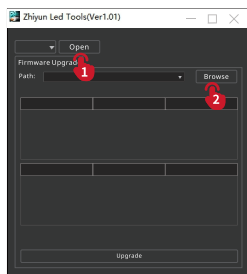
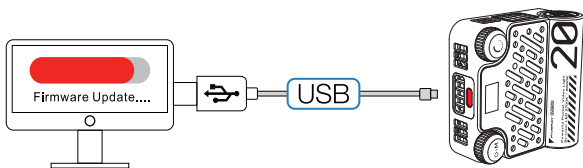

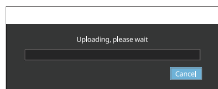
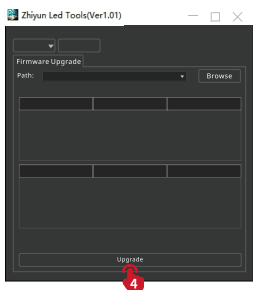

💡 During the upgrade process, please wait for the display screen to show that the upgrade is successful before unplugging the USB Type-C cable.

Product Model: PLM104

Max Output Power	20W	
Battery Capacity	4500mAh	
Color Temperature Range	2700k-6500k	
Dimming Range	0-100%	
CRI/TLCI	CRI \geq 95 TLCI \geq 97	
LED Chip	20pcs cool light +20pcs warm light	
Illuminance (Max power, without reflector)	2010(lux)	Lab Data 1
Charging Time (PD fast charging)	2H	Lab Data 2
Runtime (Max power)	40min	Lab Data 3
Operation Temperature	-10°C -40°C	
Product Size	78x78x35.75mm	
Product Net Weight	200g	

Lab Data 1: The data is collected under the following conditions: 25°C temperature, indoor illuminance lower than 0.1lux, test distance 1m, and the color temperature is set at 4300K with 100% brightness. The illuminance is 2010 lux. The actual illuminance varies under different conditions.

Lab Data 2: This data was tested under the condition of an ambient temperature of 25°C, using a 27W PD fast charger. The charging time is 2 hours. The actual charging time may vary due to different environmental conditions. The lower the charging environment temperature, the smaller the charging current, and the longer the charging time will be extended.

Lab Data 3: This data was tested under the condition of an ambient temperature of 25°C, with the fill light fully charged, in CCT mode, with a color temperature of 4300k, and a brightness of 100%. The continuous working time is 40 minutes. The actual continuous working time may vary due to different usage times of the fill light, the number of battery charge and discharge cycles, and battery activity. The longer the fill light is used, the more battery charge and discharge cycles, the lower the battery activity, and the continuous use time will be shortened accordingly.

Thank you for purchasing this product. The information contains herein affects your safety, legitimate rights and obligation. Please read this instruction carefully to ensure proper configuration before use. Failure to read and follow this instruction and warnings herein may result in serious injury to you or bystanders, or damage to your device or property. Guilin Zhishen Information Technology Co., Ltd (hereinafter referred to as "ZHIYUN") reserves all rights for final explanation of this instruction and other documents related to this product. The information is subject to update without notice. Please visit www.zhiyun-tech.com to obtain the latest product information.

By using this product, you hereby signify that you have read this document carefully and that you understand and agree to abide by the terms and conditions herein. You agree that you are solely responsible for your own conduct while using this product, and for any consequences thereof. You agree to use this product only for purposes that are proper and in accordance with all terms, precautions, practices, policies and guidelines ZHIYUN has made and may make available.

ZHIYUN accepts no liability for damage, injury or any legal responsibility incurred directly or indirectly from the use of this product. Users shall observe safe and lawful practices including, but not limited to, those set forth herein.

ZHIYUN™ is the trademark of Guilin Zhishen Information Technology Co., Ltd and its affiliates. All product names or trademarks referred to herein are trademarks or registered trademarks of their respective holders.

Reading Tips

Legends:  Hints and Tips  Important

Safe Operation Instructions

Read the ENTIRE User Guide to become familiar with the features of this product before operating. Failure to operate the product correctly can result in damage to the product or personal property and cause serious injury. This is a sophisticated product. It must be operated with caution and common sense and requires some basic mechanical ability. Failure to operate this product in a safe and responsible manner could result in injury or damage to the product or other property. This product is not intended for use by children without direct adult supervision. DO NOT use with incompatible components or in any way otherwise as mentioned or instructed in the product documents provided by ZHIYUN. The safety guidelines herein contain instructions for safety, operation and maintenance. It is essential to read and follow all of the instructions and warnings in the User Guide, prior to assembly, setup or use, in order to operate the product correctly and avoid damage or serious injury.

Warranty Period

1. Customers are entitled to replacement or free repair service in case of quality deficits found in the product within 15 days upon receipt of the product.
2. Customers are entitled to free repair service from ZHIYUN for any product proven defective in material or workmanship that results in product failure during normal consumer usage and conditions within the valid warranty period, which is 12 months counting from the date of selling. However, warranty period varies by product component and country of purchase. Please contact our after-sales service team on ZHIYUN official website or your place of purchase for detailed warranty information.

Warranty Exclusions

1. Products subjected to unauthorized repair, misuse, collision, neglect, mishandling, soaking, accident, and unauthorized alteration.
2. Products subjected to improper use or whose labels or security tags have been torn off or altered.
3. Products whose warranty has expired.
4. Products damaged due to force majeure, such as fire, flood, lightning, etc.

Warranty Claim Procedure

1. If failure or any problem occurs to your product after purchase, please contact a local agent for assistance, or you can always contact ZHIYUN's customer service through email at info@zhiyun-tech.com or website at www.zhiyun-tech.com.
2. Your local agent or ZHIYUN's customer service will guide you through the whole service procedure regarding any product issue or problem you have encountered. ZHIYUN reserves the right to reexamine damaged or returned products.

Customer Information

Customer Name:

Phone Number:

Address:

Sales Information

Sales date:

Product Serial Number:

Distributor Name:

Distributor's Contact Number:

First Maintenance Record

Service Date:

Repairman Signature:

Cause of Problem:

Service Result:

Solved

Unsolved

Refunded/Replaced



Website



Weibo



Vimeo



Google+



Facebook
(Zhiyun Support)



Facebook
(Zhiyun Tech)



Youku



Youtube



Wechat



Instagram

Tel: +86 400 900 6868

USA Hotline: +1 808-319-6137,9:00-18:00 GMT-7,Mon-Fri

Europe Hotline: +49 (0) 61018132180,10:00-17:00 GMT+1,Mon-Fri

Web: www.zhiyun-tech.com

E-mail: info@zhiyun-tech.com

Address: 09 Huangtong Road, Tieshan Industrial Zone, Qixing District, Guilin, 541004, Guangxi, China

Certificate of Quality

This product is confirmed to meet quality standards and permitted for sale after strict inspection.

QC Inspector: _____



For full product information, please visit ZHIYUN's official website: Content on www.zhiyun-tech.com is subject to update without notice.

ZHIYUN™ is a trademark of ZHISHEN

All product names or brands referred to hereunder may be trademarks or registered trademarks of their respective holders.

Copyright © 2023 ZHISHEN. All rights reserved.

ZHIYUN-TECH.COM